

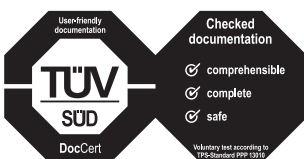

The IMPRESSA J7 Manual



The 'IMPRESSA Manual' has been awarded the seal of approval by the independent German Technical Inspection Agency, TÜV SÜD, due to its easy-to-understand style, its thoroughness and coverage of safety aspects.

Your IMPRESSA J7

IMPORTANT SAFEGUARDS	4
Control elements	8
Proper use	10
For your safety	10
The IMPRESSA J7 Manual	13
Symbol description.....	13
1 IMPRESSA J7	14
Connector System®	15
JURA on the internet.....	15
Knowledge Builder.....	15
2 Preparing and using for the first time	16
Supplied as standard.....	16
Setting up.....	16
Filling the water tank.....	16
Filling the bean container.....	17
First-time use.....	17
Inserting and activating the filter.....	18
Determining and adjusting the water hardness.....	19
Adjusting the grinder.....	20
Switching on.....	21
Switching off.....	22
3 Familiarising yourself with the control options	23
Preparation at the touch of a button.....	23
One-off settings before and during preparation.....	24
Permanently setting the amount of water for the cup size.....	26
Permanent settings in programming mode.....	26
4 Preparation at the touch of a button	29
Ristretto, espresso and coffee.....	29
Cappuccino.....	30
Pre-ground coffee.....	31
Foaming and heating milk with the Professional Cappuccino Frother.....	32
Foaming milk with the Easy Cappuccino Frother.....	33
Hot water.....	34

5	Permanent settings in programming mode	35
	Products.....	35
	Energy-saving mode	36
	Automatic switch-off.....	37
	Rinsing.....	38
	Restore factory settings	38
	Viewing information and maintenance status	39
	Unit for amount of water.....	40
	Language.....	41
6	Maintenance	42
	Maintenance tips.....	42
	Rinsing the machine.....	42
	Changing the filter	43
	Cleaning the machine	45
	Descaling the machine.....	46
	Rinsing the cappuccino frother	48
	Cleaning the cappuccino frother.....	49
	Dismantling and rinsing the Professional Cappuccino Frother	51
	Dismantling and rinsing the Easy Cappuccino Frother.....	51
	Cleaning the bean container	51
	Descaling the water tank.....	52
7	Display messages	53
8	Troubleshooting	55
9	Transport and environmentally neutral disposal	57
	Transport / Emptying the system.....	57
	Disposal.....	57
10	Technical data	58
	Index	59
	JURA contact details / Legal information	64

IMPORTANT SAFEGUARDS

These safeguards apply for machines with UL safety test (see rating plate and chapter 10, 'Technical data').

Follow the basic safety precautions

When using electrical appliances, basic safety precautions should always be followed, to reduce the risk of fire, electric shock, and/or injury to persons, including the following:

- Read all instructions.
- Do not touch hot surfaces. Use handles or knobs.
- To protect against fire, electric shock and injury to persons, do not immerse cord, plugs, or body of machine in water or other liquid.
- Close supervision is necessary when any appliance is used by or near children.
- Unplug from outlet when not in use and before cleaning. Allow to cool before putting or taking off parts, and before cleaning the appliance.
- Do not operate any appliance with a damaged cord or plug or after the appliance malfunctions, or has been damaged in any manner. Return appliance to the nearest authorized service facility for examination, repair or adjustment.
- The use of accessory attachment not recommended by the appliance manufacturer may result in fire, electric shock, or injury to persons.
- Do not use outdoors.
- Do not let the cord hang over the edge of a table or counter, or touch hot surfaces.
- Do not place on or near a hot gas or electric burner, or in a heated oven.
- Always attach plug to appliance first, then plug cord into the wall outlet. To disconnect, turn any control to 'OFF' then remove plug from wall outlet.
- Do not use appliance for other than intended use.
- Use extreme caution when dispensing hot steam.
- For household use only.

SAVE THESE INSTRUCTIONS

Special cord set instructions

- a. A short power supply cord is provided to reduce the risk resulting from becoming entangled in or tripping over a long cord.
Your IMPRESSA has a 3-pin grounded plug.
 - b. Longer extension cords are available and may be used if care is exercised in their use.
 - c. If an extension cord is used,
 1. the marked electrical rating of the extension cord should be at least as great as the electrical rating of the appliance, and
 2. if the appliance is of the grounded type, the extension cord should be a grounding type 3-wire cord, and
 3. the longer cord shall be arranged so that it will not drape over the counter top or tabletop where it can be pulled on by children or tripped over.
- As a safety feature, this plug will fit in a polarized outlet only one way.
 - If the plug does not fit fully in the outlet, reverse the plug. If it still does not fit, contact a qualified electrician.
 - Do not modify the plug in any way or attempt to defeat this safety feature.

Warning

To reduce the risk of fire or electric shock, do not remove any service covers. No user serviceable parts inside. Repair should be done by authorized personnel only.

Caution

This appliance is for household use. Any servicing other than cleaning and user maintenance should be performed by an authorized service representative:

- Do not immerse base in water or try to disassemble.
- To reduce the risk of fire or electric shock, do not remove the base. No user serviceable parts inside. Repair should be done by authorized service personnel only.
- Check voltage to be sure that the voltage indicated on the name plate agrees with your voltage.
- Never use warm or hot water to fill the water container! Use cold water only.

Important Safeguards

NEVER DO (or you will void your warranty protection):

- Keep your hands and the cord away from hot parts of the appliance during operation.
- Never clean with scouring powders or hard implements.

- Never fill instant coffee, chocolate mix etc. into the grinder or ground coffee funnel (grinder by-pass). It will damage the functioning of the brewing chamber.
- Never fill sugar coated coffee beans into the bean hopper. In case of doubt, call your dealer.
- Never fill anything other than coffee beans into the bean container (no chocolate, no rice, no nuts, no spices, nothing other than roasted coffee beans).
- Never do anything with the machine which is not described in the User's Manual. In case of doubt, call your dealer.

Control elements

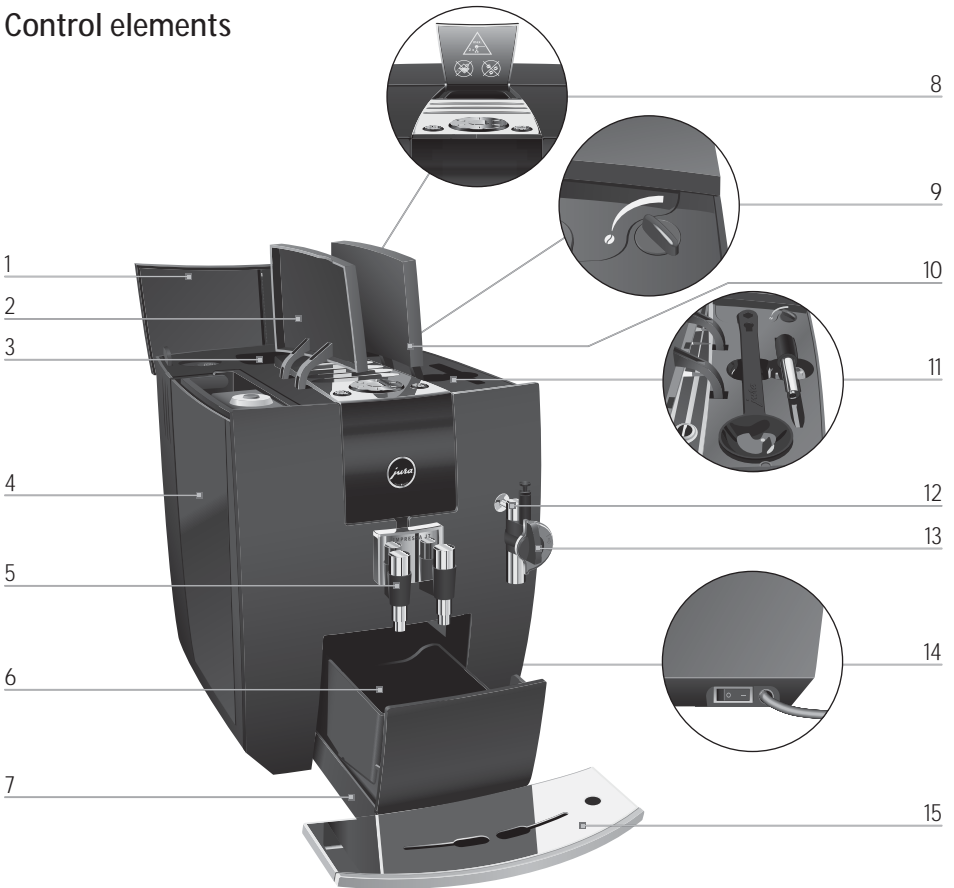



Figure: IMPRESSA J7 Piano Black









- | | | | |
|---|--|----|---|
| 1 | Bean container cover | 8 | Filler funnel for pre-ground coffee |
| 2 | Water tank cover | 9 | Grinder adjustment switch |
| 3 | Bean container with aroma preservation cover | 10 | Storage compartment cover |
| 4 | Water tank | 11 | Storage compartment with measuring spoon for pre-ground coffee and hot water nozzle |
| 5 | Height- and width-adjustable coffee spout | 12 | Connector System® for removable frothers and nozzles |
| 6 | Coffee grounds container | 13 | Professional Cappuccino Frother |
| 7 | Drip tray | 14 | Power switch and mains cable (side of machine) |
| | | 15 | Cup platform |



Surface of the machine:

- 1  On/off button
- 2 Rotary Switch
- 3  Maintenance button

Front:

- 4 Display
- START** Start symbol
-  Ristretto symbol
-  Espresso symbol
-  Coffee symbol
-  Mild
-  Normal
-  Strong
-  Hot water symbol
-  Steam symbol

The Connector System® permits the use of different frothers and nozzles. These are available from stockists.

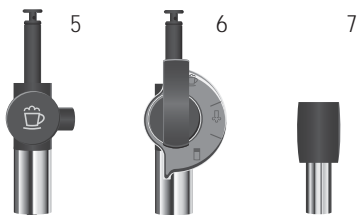

- 5 Easy Cappuccino Frother
- 6 Professional Cappuccino Frother
- 7 Hot water nozzle

Proper use

The machine is designed and intended for private domestic use. It should only be used for coffee preparation and to heat milk and water. Use for any other purpose will be deemed improper. JURA Elektroapparate AG cannot accept any responsibility for the consequences of improper use.

Before using the machine always read this manual thoroughly and completely and comply with the instructions it contains. Keep this IMPRESSA Manual close to the machine and pass it on to the next user if applicable.

For your safety



Please carefully read and observe the important safety information set out below.

To avoid danger of potentially fatal electric shock:

- Never use a machine which is damaged or has a defective mains cable.
- In the event of signs of damage, for example if there is a smell of burning, unplug the machine immediately from the mains supply and contact JURA service.
- If the mains cable of this machine is damaged, it must be repaired either directly by JURA or by an authorised JURA service centre.
- Make sure that the IMPRESSA and the mains cable are not located close to hot surfaces.
- Be careful to ensure that the mains cable does not get caught and does not rub against sharp edges.
- Never open and repair the machine yourself. Do not modify the machine in any way that is not described in the IMPRESSA Manual. The machine contains live parts. If opened, there is a danger of potentially fatal injury. Repairs may only be carried out by authorised JURA service centres, using original spare parts and accessories.

There is a risk of scalds or burns on the spouts or the frother:

- Place the machine out of the reach of children.
- Do not touch any hot parts. Use the handles provided.
- Be careful to ensure that the appropriate frother is correctly installed and clean. The frother or parts of the frother might come off if the parts are not assembled correctly or a blockage occurs.

A defective machine is not safe and could cause injury or fire. To avoid damage and any associated risk of injury or fire:

- Never allow the mains cable to loosely hang down. The mains cable could pose a tripping hazard or become damaged.
- Protect your IMPRESSA from environmental influences such as rain, frost and direct sunlight.
- Do not immerse the IMPRESSA, cable or connections in water.
- Do not put the IMPRESSA or any individual parts in the dishwasher.
- Turn your IMPRESSA off at the power switch before any cleaning operation. Always wipe your IMPRESSA with a damp cloth rather than a wet one, and protect it from prolonged exposure to water splashes.
- Only connect the machine to a mains voltage in accordance with the information on the rating plate. The rating plate is located on the underside of your IMPRESSA. Further technical data is given in Chapter 10 'Technical data'.
- Please only use original JURA maintenance products. Use of products that are not explicitly recommended by JURA could damage the IMPRESSA.
- Do not use any coffee beans treated with additives or caramelised coffee beans.
- Only fill the water tank with cold, fresh water.
- Switch the machine off at the power switch if you are going to be absent for a longer period of time.

Important information

People, including children, who

- do not have the physical, sensory or mental capabilities to use the machine safely or
- are inexperienced or lack knowledge in how to use the machine safely

must be supervised by a responsible person when using it, or must be instructed in how to use it correctly.

Safety when handling the CLARIS Blue filter cartridge:

- Filter cartridges should be kept out of the reach of children.
- Store filter cartridges in a dry place in the sealed packaging.
- Protect cartridges from heat and direct sunlight.
- Do not use damaged cartridges.
- Do not open filter cartridges.

The IMPRESSA J7 Manual

You are holding the manual for your IMPRESSA J7 in your hand. It will help you to familiarise yourself with your IMPRESSA safely and quickly and teach you the full range of facilities it offers:

- Chapter 2, 'Preparing and using for the first time', explains step-by-step how to set up and prepare the machine.
- Chapter 3, 'Familiarising yourself with the control options' is important for you to read as you are familiarising yourself with your IMPRESSA.
- All the other chapters are intended to help you when you have a specific query.

@ You can download the short operating instructions for your machine from the JURA website (www.jura.com).

Symbol description

Warnings

 CAUTION	Always take note of any information marked with the words CAUTION or WARNING and a warning sign. The signal word WARNING draws your attention to potential serious injury, and the signal word CAUTION to potential minor injury.
CAUTION	CAUTION draws your attention to potential damage to the machine.

Symbols used

i	Information and tips to make it even easier to use your IMPRESSA.
@	References to the JURA website , which provides further information that may be of interest to you: www.jura.com
▶	Prompt to take action. This symbol means that you are being prompted to perform some action.
READY	Display message

1 IMPRESSA J7

Perfect enjoyment, perfect aesthetics

The uncompromising all-round design of the IMPRESSA J7 indulges the eyes as well as the taste buds. Gourmets will find plenty to delight them as their coffee dreams come true and they experience a new dimension of enjoyment with ristretto, espresso, coffee crème, cappuccino, latte macchiato and many other trendy specialities. This is easy to achieve, because the innovative operating concept leaves nothing to be desired when it comes to simplicity. And the integrated cup illumination places every speciality coffee in the right light.



- **Breathtakingly beautiful:** Clear, no-frill contours and high-quality materials set the tone of the design of the IMPRESSA J series. All details have been exactly thought out and come together to form an aesthetic whole that impresses in every way. This makes the IMPRESSA J7 a true design feature in the home, which, thanks to its compact design, can easily be placed anywhere.
- **Pure ergonomics:** The centrally arranged control elements, with the unique Rotary Switch and a plain text display which speaks your language, will allow you to quickly and intuitively make your coffee wishes come true. The focus is fully on your personal taste. Simply select the coffee strength, amount of water and temperature according to your individual preferences. You can even choose between three hot water temperature levels. Accessories such as the measuring spoon and the hot water nozzle can be conveniently stored in the storage compartment where they are always within reach.
- **Energy-saving made easy:** The IMPRESSA J7 actively assists you in saving energy.
 - With the Energy Save Mode (E.S.M.®) you can adjust the energy saving potential to suit the way you like to enjoy your beverages.

- **Zero-Energy Switch:** When the IMPRESSA is switched off with the on/off button, the machine is completely disconnected from the power supply.



- **Height- and width-adjustable coffee spout:** The height- and width-adjustable coffee spout is another JURA innovation. It allows precise adaptation to cups of different heights and diameters. This prevents the coffee from splashing and produces a delicious crema with the ideal consistency.

Connector System®

The Connector System® permits the use of different cappuccino frothers:

- Professional Cappuccino Frother
 - Cappuccino, latte macchiato
 - Hot milk and milk foam
- Easy Cappuccino Frother
 - Cappuccino
 - Milk foam

JURA on the internet

Visit us on the internet.

- @ At www.jura.com you will find interesting and up-to-date information on your IMPRESSA and on every aspect of coffee.

Knowledge Builder

You can familiarise yourself with your IMPRESSA in a fun way on the PC.

- @ The Knowledge Builder awaits you at www.jura.com. The interactive assistant, LEO, will assist you and explain the benefits of and how to use your IMPRESSA.

2 Preparing and using for the first time

This chapter provides you with the information you need to use your IMPRESSA without any problems. You will prepare your IMPRESSA step-by-step to enjoy your first perfect cup of coffee.

Supplied as standard

The following items are supplied as standard:

- Your JURA IMPRESSA J7 automatic coffee machine
- The Welcome Pack, which includes:
 - The IMPRESSA J7 Manual
 - JURA cleaning tablets
 - Measuring spoon
 - Hot water nozzle
 - Aquadur® test strip
 - CLARIS Blue extension
 - CLARIS Blue filter cartridge
 - JURA Cappuccino Cleaner

Setting up

Keep the packaging for your IMPRESSA. It should be used to protect the machine during transport.

When setting up your IMPRESSA, please note the following:

- Set the IMPRESSA down on a horizontal surface that is not sensitive to water.
- Choose a spot for your IMPRESSA which is protected against overheating.

Filling the water tank

To enjoy the perfect cup of coffee we recommend changing the water every day.

CAUTION

Milk, mineral water or other liquids can damage the water tank or the machine.

- ▶ Only fill the water tank with fresh, cold water.
-
- ▶ Open the water tank cover.
 - ▶ Remove the water tank and rinse it with cold water.
 - ▶ Fill the water tank with fresh, cold water and reinsert the tank.
 - ▶ Close the water tank cover.

Filling the bean container

CAUTION

The bean container has an aroma preservation cover. This will ensure that your coffee beans retain their aroma for longer.

Coffee beans which have been treated with additives (e.g. sugar), pre-ground coffee or freeze-dried coffee will damage the grinder.

- ▶ Only use untreated coffee beans to refill the bean container.
-
- ▶ Open the bean container cover and remove the aroma preservation cover.
 - ▶ Remove any dirt or foreign objects inside the bean container.
 - ▶ Fill the bean container with coffee beans, then close the aroma preservation cover and the bean container cover.

First-time use









WARNING

If the machine is operated with a defective mains cable, there is a danger of potentially fatal electric shock.

- ▶ Never use a machine which has a defective mains cable.
-



Precondition: The water tank and bean container are full.

- ▶ Insert the mains plug into a power socket.
-  ▶ Switch on the IMPRESSA using the power switch on the right-hand side of the machine.
-  ▶ Press the on/off button to switch the IMPRESSA on. The Rotary Switch lights up. **SPRACHE DEUTSCH** appears on the display.
-  ▶ Turn the Rotary Switch until the required language is displayed, for example **LANGUAGE ENGLISH**.
-  ▶ Press the Rotary Switch to confirm the language. **OK** appears briefly on the display to confirm the setting. **PRESS RINSE**, the maintenance button  lights up.
- ▶ Place a receptacle under the frother.
-  ▶ Press the maintenance button. **SYSTEM FILLING**, the system fills up with water. A small amount of water flows from the frother. This operation stops automatically, the following appears on the display: **HEATING**. **PRESS RINSE**, the maintenance button  lights up.

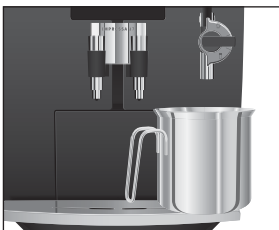

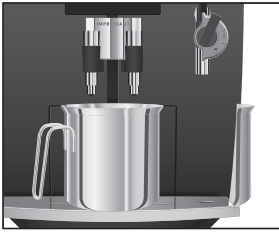

Inserting and activating the filter

- ▶ Place a receptacle under the coffee spout.
- ⚡ ▶ Press the maintenance button.
RINSING, the machine rinses. The operation stops automatically.
READY appears on the display. Your IMPRESSA is ready for use.

Your IMPRESSA no longer has to be descaled if you are using CLARIS Blue filter cartridges.

@ You can also try out the 'Inserting the filter' operation online. Visit the Knowledge Builder at www.jura.com.

- i** Perform the 'Inserting the filter' operation without interruptions. This will ensure that your IMPRESSA always produces its best.

Precondition: **READY** is displayed.

- 🕒 ▶ Keep the Rotary Switch pressed **until RINSE** appears on the display.
- 🕒 ▶ Turn the Rotary Switch until **FILTER —** is displayed.
- 🕒 ▶ Press the Rotary Switch to enter the programme item.
NO —
- 🕒 ▶ Turn the Rotary Switch until **YES ✓** is displayed.
- 🕒 ▶ Press the Rotary Switch to confirm the setting.
OK appears briefly on the display to confirm the setting.
INSERT, the maintenance button ⚡ lights up.
 - ▶ Remove the filter cartridge extension from the Welcome Pack.
 - ▶ Fit the extension on top of an original CLARIS Blue filter cartridge.
 - ▶ Remove and empty the water tank.
 - ▶ Lift the cartridge holder and insert the filter cartridge into the water tank, exerting slight pressure.
 - ▶ Close the cartridge holder. It will click into place audibly.



- i** After two months, the filter will cease to work. You can check the elapsed time by referring to the date plate on the cartridge holder in the water tank.



- ▶ Fill the water tank with fresh, cold water and reinsert the tank.
- ▶ Place a receptacle (at least 500 ml) under the frother.

i If you are using the **Professional Cappuccino Frother**, set the selector switch of the frother to the steam position .

-  ▶ Press the maintenance button.

FILTER RINSING. Water flows out of the frother.

i You can interrupt rinsing of the filter at any time by pressing the maintenance button .

i The water may be slightly discoloured. This is not harmful to health and does not affect the taste.

Rinsing of the filter stops automatically after approximately 500 ml. **HEATING** appears on the display, then **READY** is displayed. The filter is now activated.

i If you are using the CLARIS Blue filter cartridge and have activated it in programming mode, you will not be able to adjust the water hardness.

Determining and adjusting the water hardness

The harder the water is, the more frequently the IMPRESSA needs to be descaled. It is therefore important to adjust the water hardness.

The water hardness can be adjusted on a continuous scale between 1° dH and 30° dH. This can also be deactivated, which means that the IMPRESSA will not let you know when it has to be descaled.

Determining the water hardness

You can find out what the water hardness is by using the Aquadur® test strip supplied as standard.

- ▶ Hold the test strip briefly (for one second) under flowing water. Shake off the water.
- ▶ Wait for about one minute.
- ▶ You will then be able to read the degree of water hardness from the discolouration of the Aquadur® test strip and the description on the packaging.

You can now adjust the water hardness.

Adjusting the water hardness

Example: Proceed as follows to change the water hardness from 16° dH to 25° dH.

Precondition: READY is displayed.

- ▶ Keep the Rotary Switch pressed until RINSE appears on the display.
- ▶ Turn the Rotary Switch until HARDNESS is displayed.
- ▶ Press the Rotary Switch to enter the programme item.
16° dH
- ▶ Turn the Rotary Switch until 25° dH is displayed.
- ▶ Press the Rotary Switch to confirm the setting.
OK appears briefly on the display to confirm the setting.
HARDNESS
- ▶ Turn the Rotary Switch until EXIT is displayed.
- ▶ Press the Rotary Switch to exit programming mode.
READY appears on the display.

Adjusting the grinder

You can adjust the grinder on a continuous scale to suit the roast of your coffee.

CAUTION

If you adjust the consistency of grind when the grinder is not operating, the grinder adjustment switch could be damaged.

- ▶ Only adjust the consistency of grind when the grinder is running.

The consistency of grind setting is correct if the coffee flows regularly from the coffee spout. In addition a fine, thick crema forms.

Our recommendations:

- Select a fine setting for a light roast.
- If the consistency of grind is **too fine**, the coffee only flows in drips from the coffee spout.



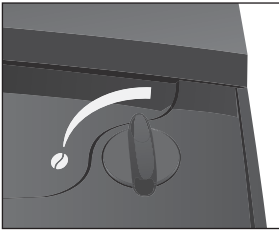

- Select a coarse setting for a darker roast.
 - If the consistency of grind is **too coarse**, the coffee flows too quickly from the coffee spout.

Example: Proceed as follows to change the consistency of grind **during** the preparation of an espresso.

- ▶ Open the cover of the storage compartment.
- ▶ Place a cup under the coffee spout.
- ☑ ▶ Touch the Espresso symbol.
 - ▶ **ESPRESSO** is displayed for about two seconds and the Espresso symbol is active.
 - ▶ **READY**

- START ▶ Touch the Start symbol.
 - ▶ The grinder starts and **ESPRESSO** appears on the display.
 - ▶ Turn the grinder adjustment switch to the desired position **while** the grinder is running.
 - ▶ The coffee will be prepared and the consistency of grind is adjusted.
 - ▶ Close the cover of the storage compartment.



Switching on



Precondition: Your IMPRESSA is switched on at the power switch.

- ☑ ▶ Press the on/off button to switch the IMPRESSA on.
 - ▶ **HEATING** appears on the display.
 - ▶ **PRESS RINSE**, the maintenance button ☘ lights up.
 - ▶ Place a receptacle under the coffee spout.
 - ☘ ▶ Press the maintenance button.
 - ▶ **RINSING**, the machine rinses.
 - ▶ The operation stops automatically. **READY** appears on the display.

Switching off

When you switch your IMPRESSA off, the coffee spout is only rinsed if you have prepared a speciality coffee.



- ▶ Place a receptacle under the coffee spout.
- ▶ Press the on/off button.
RINSING, the coffee spout is rinsed.
The IMPRESSA is switched off.



3 Familiarising yourself with the control options

With the IMPRESSA, you can prepare an excellent coffee or milk speciality at the touch of a button. You also have the option of adjusting the coffee strength and temperature, as well as the amount of water to your personal taste.

This chapter will allow you to become familiar with all control options with the aid of examples. To familiarise yourself with your IMPRESSA, we recommend that you make a point of actively trying the facilities described in this chapter. You will find this is well worthwhile.

Familiarise yourself with the following control options:

- Preparation at the touch of a button
- One-off settings **before** and **during** preparation
- Entering a permanent setting for the amount of water for the cup size
- Permanent settings in programming mode

i You can interrupt the machine at any time while a speciality coffee, hot water or steam is being prepared. To do this, press the Rotary Switch  or the maintenance button  or touch the Start symbol **START**.

i The last product prepared and the corresponding coffee strength are always active.

@ If you prefer to familiarise yourself with your IMPRESSA in a fun way on the computer, the interactive Knowledge Builder tutorial program can be found on the Internet at www.jura.com.

Preparation at the touch of a button

Prepare your favourite speciality coffee at the touch of a button.

All speciality coffees are prepared following this model at the touch of a button.

Preparing a speciality coffee at the touch of a button



Example: Proceed as follows to prepare **one** espresso.

Precondition: **READY** is displayed.

- ▶ Place an espresso cup under the coffee spout.
- ▶ Touch the Espresso symbol.
1 ESPRESSO is displayed for about two seconds. The Espresso symbol is active.
READY

START ▶ Touch the Start symbol.

Preparation will now begin. **1 ESPRESSO** appears on the display. The pre-set amount of water flows into the cup. You can follow the current status of preparation on the progress bar.

Preparation stops automatically and **READY** appears on the display.

Preparing two speciality coffees at the touch of a button



Example: Proceed as follows to prepare **two** espressi.

Precondition: **READY** is displayed.

- ▶ Place two espresso cups under the coffee spout.
- ▶ Touch the Espresso symbol twice (**within two seconds**).
2 ESPRESSI appears on the display.

START ▶ Touch the Start symbol within two seconds while **2 ESPRESSI** is displayed.

Preparation will now begin. The pre-set amount of water flows into the cups. You can follow the current status of preparation on the progress bar.

Preparation stops automatically and **READY** appears on the display.

One-off settings before and during preparation

You can change the **coffee strength** before preparation. The following coffee strengths can be selected for 1 ristretto, 1 espresso and 1 coffee:

- Mild ☉
- Normal ☉☉
- Strong ☉☉☉

i The pre-set **amount of water** can be changed during preparation by turning the Rotary Switch.

One-off settings before and during preparation always follow this model.

Changing the coffee strength before preparation



Example: Proceed as follows to prepare a **strong** cup of coffee.

Precondition: **READY** is displayed.

- ▶ Place a cup under the coffee spout.
- ☛ ▶ Touch the Strong symbol.
STRONG is displayed for about two seconds. The Strong symbol is active.
- ☛ ▶ Touch the Coffee symbol.
1 COFFEE is displayed for about two seconds. The Coffee symbol is active.
READY

START ▶ Touch the Start symbol.

Preparation will now begin. **1 COFFEE** appears on the display. The pre-set amount of water flows into the cup. You can follow the current status of preparation on the progress bar.

Preparation stops automatically and **READY** appears on the display.

Changing the amount of water during preparation



Example: Proceed as follows to prepare a **110 ML** cup of coffee.

Precondition: **READY** is displayed.

- ▶ Place a cup under the coffee spout.
- ☛ ▶ Touch the Coffee symbol.
1 COFFEE is displayed for about two seconds. The Coffee symbol is active.
READY

START ▶ Touch the Start symbol.

Preparation will now begin. **1 COFFEE** appears on the display.

- ☛ ▶ Turn the Rotary Switch **during** preparation until **110 ML** is displayed.

The set amount of water flows into the cup.

Preparation stops automatically and **READY** appears on the display.

Permanently setting the amount of water for the cup size

It is easy to make permanent settings for the amount of water for all speciality coffees as well as hot water and steam according to the cup size. As in the following example, adjust the amount of water once. Every time you prepare a drink in the future, this amount of water will be dispensed.

The permanent settings for adapting the amount of water to the cup size for all speciality coffees, hot water and steam follow this model.

Example: Proceed as follows to make **permanent** settings for the amount of water for a coffee.

Precondition: **READY** is displayed.

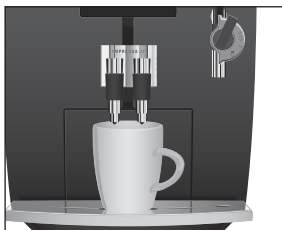

▶ Place a cup under the coffee spout.

 ▶ Touch the Coffee symbol.

1 COFFEE is displayed for about two seconds. The Coffee symbol is active.

READY

START ▶ Touch the Start symbol for **about three seconds**, until **ENOUGH COFFEE ?** appears on the display.

Preparation starts and the coffee flows into the cup.

START ▶ Touch the Start symbol as soon as there is sufficient coffee in the cup.

Preparation stops. **OK** appears briefly on the display. The set amount of water for one coffee will be permanently stored. **READY** appears on the display.

i You can alter these settings at any time by repeating the above procedure.

i You can also make permanent settings for the amount of water for all speciality coffees in programming mode, in the **BUTTONS** programme item.

Permanent settings in programming mode

You can make permanent settings in programming mode. For example, you can change product settings such as aroma and the amount of water or activate an energy-saving mode.

Simply by turning and pressing the Rotary Switch you can navigate through the easy-to-understand programme items and make permanent settings.



You can make the following settings with the Rotary Switch:

Programme item	Sub-item	Explanation
RINSE	RINSE, CLEAN, FILTER (only if filter is activated), DE-SCALE (only if filter is not activated)	▶ Select the desired maintenance programme. If no action is taken, programming mode is exited automatically after approximately five seconds.
BUTTONS	SELECT BUTTON	▶ Select your settings for speciality coffees, hot water and steam.
FILTER –	YES ✓ NO –	▶ Indicate whether you operate your IMPRESSA with or without a CLARIS Blue filter cartridge.
HARDNESS (only if filter is not activated)	INACTIVE, 1° dH – 30° dH	▶ Adjust the water hardness.
ENERGY	SAVE –, SAVE ✓	▶ Select an energy-saving mode.
OFF AFTER	15 MIN, 0.5 HRS – 15 HRS	▶ Set the time after which the IMPRESSA should switch off automatically.
RINSING	MANUAL, AUTOMATIC	▶ Set whether the switch-on rinse should be started manually or automatically.
RESET	PRODUCT, ALL PROD., RESET ALL	▶ Reset the permanently set values of all products to the factory settings.
INFO		▶ Keep track of all prepared products and view the maintenance status.
DISPLAY	ML, OZ	▶ Select the unit for the amount of water.
LANGUAGE		▶ Select your language.
EXIT		▶ Exit programming mode.

Settings in programming mode always follow the same model.









Example: Proceed as follows to change the aroma of one espresso from **INTENSIVE** to **STANDARD**.

Precondition: **READY** is displayed.

-  ▶ Keep the Rotary Switch pressed until **RINSE** appears.
-  ▶ Turn the Rotary Switch until **BUTTONS** is displayed.
-  ▶ Press the Rotary Switch to enter the programme item.
SELECT BUTTON

i Next select the product for which you would like to make settings.





i To enter a setting for the double product, touch the corresponding symbol twice within a period of two seconds.

-  ▶ Touch the Espresso symbol.
1 ESPRESSO is displayed for about two seconds.
WATER
-  ▶ Turn the Rotary Switch until **STRENGTH** is displayed.
-  ▶ Press the Rotary Switch to enter the programme item.
INTENSIVE
-  ▶ Turn the Rotary Switch until **STANDARD** is displayed.
-  ▶ Press the Rotary Switch to confirm the setting.
OK appears briefly on the display to confirm the setting.
STRENGTH
-  ▶ Turn the Rotary Switch until **EXIT** is displayed.
-  ▶ Press the Rotary Switch to exit the programme item.
BUTTONS
-  ▶ Turn the Rotary Switch until **EXIT** is displayed.
-  ▶ Press the Rotary Switch to exit programming mode.
READY



4 Preparation at the touch of a button

In this chapter you will find out how to prepare coffee and milk specialities and hot water without making further settings.

Chapter 3, 'Familiarising yourself with the control options', will teach you how to adjust the settings to your personal preferences. Alternatively, you can use Chapter 5, 'Permanent settings in programming mode'.

- i** You can interrupt the machine at any time while a speciality coffee, hot water or steam is being prepared. To do this, press the Rotary Switch  or the maintenance button  or touch the Start symbol **START**.
 - i** You can select the coffee strength of individual products before preparation: mild , normal  or strong .
 - i** During preparation, you can change the pre-set amount of water by turning the Rotary Switch.
- @ You can also try out the preparation of speciality coffees online. Visit the Knowledge Builder at www.jura.com.

Ristretto, espresso and coffee

All speciality coffees (ristretto , espresso  and coffee ) are prepared in the same way.



Example: Proceed as follows to prepare **one** coffee.

- ▶ Place a cup under the coffee spout.
-  ▶ Touch the Coffee symbol.
1 COFFEE is displayed for about two seconds. The Coffee symbol is active.
READY
- START** ▶ Touch the Start symbol.
 Preparation will now begin. **1 COFFEE** appears on the display. The pre-set amount of water flows into the cup. You can follow the current status of preparation on the progress bar.
 Preparation stops automatically and **READY** appears on the display.

Preparing two speciality coffees at the touch of a button

Cappuccino

To prepare two cups of coffee: Place two cups under the coffee spout and touch the Coffee symbol  twice (**within two seconds**). Touch the Start symbol **START** within two seconds to start preparation.

For a cappuccino you must first froth the milk using the cappuccino frother. You then prepare an espresso straight into the milk foam.

i The following procedure applies to both the **Professional** and **Easy Cappuccino Frothers**.

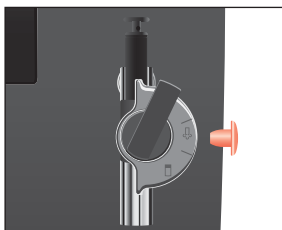

- ▶ Remove the protective cover from the frother.
- ▶ Attach the milk pipe to the frother.
- ▶ Insert the other end of the milk pipe into a milk carton or connect it to a milk container.

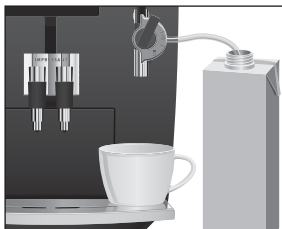



- ▶ Place a cup under the frother.
- ▶ If you are using the **Professional Cappuccino Frother**, set the selector switch to the milk foam position .
- ⇓ ▶ Touch the Steam symbol.

HEATING

As soon as the machine has heated up, **READY** appears.

- ⇓ ▶ Touch the Steam symbol again.
STEAM, the milk foam is prepared. You can follow the current status of preparation on the progress bar.
Preparation stops automatically when the pre-set amount of steam is reached.

i The milk foam preparation can be interrupted at any time. To do this, press the Rotary Switch  or the maintenance button  or touch the Start symbol **START**.

i You can prepare more milk foam within about 40 seconds without having to wait for the machine to heat.

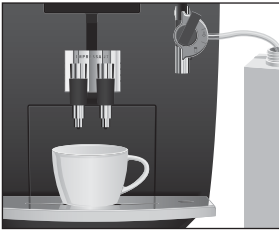

- ▶ Place the cup under the coffee spout.
- ☞ ▶ Touch the Espresso symbol.
 1 ESPRESSO is displayed for about two seconds. The Espresso symbol is active.
 READY
- START ▶ Touch the Start symbol.
 Preparation will now begin. *1 ESPRESSO* appears on the display. The pre-set amount of water flows into the cup. Preparation stops automatically and *READY* appears on the display.

To make sure the cappuccino frother always works properly, rinse and clean it regularly (see Chapter 6, 'Maintenance – Cappuccino frother').

Pre-ground coffee

You can choose a second coffee variety, for example decaffeinated coffee, with the filler funnel for pre-ground coffee.

- i** Never add more than two level measuring spoons of pre-ground coffee.
- i** Use pre-ground coffee which is not ground too finely. Very fine coffee can block up the system so that the coffee only comes out in drips.
- i** If you did not fill the machine with a sufficient amount of pre-ground coffee, *NOT ENOUGH PRE-GROUND* is displayed and the IMPRESSA stops operation.
- i** The desired speciality coffee must be prepared within approximately one minute after filling with the pre-ground coffee. Otherwise the IMPRESSA stops the operation and is ready for use again.

All speciality coffees with pre-ground coffee are prepared following this model.

Example: Proceed as follows to prepare a cup of coffee using pre-ground coffee.

- ▶ Place a cup under the coffee spout.
- ▶ Open the cover of the storage compartment, take out the measuring spoon for pre-ground coffee and close the cover again.

4 Preparation at the touch of a button



- ▶ Open the cover of the filler funnel for pre-ground coffee.
FILL PRE-GROUND
- ▶ Place one level measuring spoon of pre-ground coffee into the filler funnel.
- ▶ Close the cover of the filler funnel for pre-ground coffee.
SELECT BUTTON



- ▶ Touch the Coffee symbol.
☕ COFFEE appears on the display.

START

- ▶ Touch the Start symbol.
Preparation will now begin. The pre-set amount of water flows into the cup. You can follow the current status of preparation on the progress bar.
Preparation stops automatically and **READY** appears on the display.

Foaming and heating milk with the Professional Cappuccino Frother

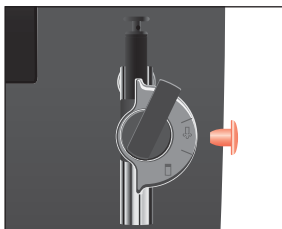

- ▶ Remove the protective cover from the frother.
- ▶ Attach the milk pipe to the frother.
- ▶ Insert the other end of the milk pipe into a milk carton or connect it to a milk container.

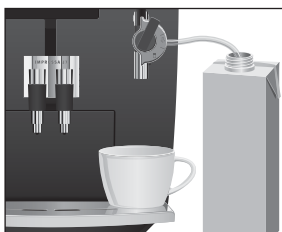

- ▶ Place a cup under the frother.
- ▶ Turn the selector switch of the frother to the milk foam position .



- If you want to **heat the milk**, set the selector switch of the frother to the milk position .





- ▶ Touch the Steam symbol.
HEATING
As soon as the machine has heated up, **READY** appears.



- ▶ Touch the Steam symbol again.
STEAM, the milk foam is prepared. You can follow the current status of preparation on the progress bar.

Preparation stops automatically when the pre-set amount of steam is reached.



- i** The milk foam preparation can be interrupted at any time. To do this, press the Rotary Switch  or the maintenance button  or touch the Start symbol **START**.
- i** You can prepare more milk foam or heat the milk within about 40 seconds without having to wait for the machine to heat.

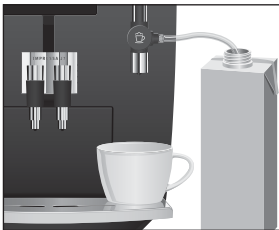
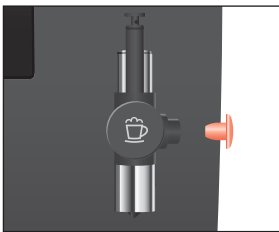

To make sure the cappuccino frother always works properly, rinse and clean it regularly (see Chapter 6, 'Maintenance – Cappuccino frother').

Foaming milk with the Easy Cappuccino Frother



- ▶ Remove the protective cover from the frother.
- ▶ Attach the milk pipe to the frother.
- ▶ Insert the other end of the milk pipe into a milk carton or connect it to a milk container.

- ▶ Place a cup under the frother.
-  ▶ Touch the Steam symbol.
HEATING
As soon as the machine has heated up, **READY** appears.
-  ▶ Touch the Steam symbol again.
STEAM, the milk foam is prepared. You can follow the current status of preparation on the progress bar.
Preparation stops automatically when the pre-set amount of steam is reached.

- i** The milk foam preparation can be interrupted at any time. To do this, press the Rotary Switch  or the maintenance button  or touch the Start symbol **START**.
- i** You can prepare more milk foam within about 40 seconds without having to wait for the machine to heat.

To make sure the cappuccino frother always works properly, rinse and clean it regularly (see Chapter 6, 'Maintenance – Cappuccino frother').

Hot water

To obtain a perfect water flow, use the removable hot water nozzle. You can find the hot water nozzle under the cover of the storage compartment.

The following temperatures can be selected for preparing hot water:

- Regular
- Normal
- Hot



There is a danger of scalding from hot water splashes.

- ▶ Avoid direct contact with the skin.
-

First attach the hot water nozzle:

- ▶ Carefully remove the cappuccino frother from the Connector System® by twisting slightly.
- ▶ Open the cover of the storage compartment, take out the hot water nozzle and close the cover again.
- ▶ Attach the hot water nozzle to the Connector System®, rotating it slightly.
- ▶ Place a cup under the hot water nozzle.



- ▶ Touch the Hot water symbol.

WATER appears on the display, and the temperature is briefly displayed, e.g. **NORMAL**.



By touching the Hot water symbol several times (**within approximately 2 seconds**) you can set the temperature to your individual preference. This setting is not saved.

Hot water flows into the cup. You can follow the current status of preparation on the progress bar.

Preparation stops automatically and **READY** appears on the display.



During preparation, you can change the amount by turning the Rotary Switch.



5 Permanent settings in programming mode

Products



With the **BUTTONS** programme item you can enter individual settings for all speciality coffees, hot water and steam.



The following permanent settings can be made:

Product	Amount	Strength	Temperature
1 ristretto	25 ML – 240 ML	STANDARD, INTENSIVE	NORMAL, HIGH
2 ristretti (per cup)	25 ML – 240 ML	–	NORMAL, HIGH
1 espresso	25 ML – 240 ML	STANDARD, INTENSIVE	NORMAL, HIGH
2 espressi (per cup)	25 ML – 240 ML	–	NORMAL, HIGH
1 coffee	25 ML – 240 ML	STANDARD, INTENSIVE	NORMAL, HIGH
2 coffees (per cup)	25 ML – 240 ML	–	NORMAL, HIGH
Hot water	25 ML – 240 ML	–	REGULAR, NORMAL, HOT
Steam	3 SEC – 120 SEC	–	–













Permanent settings in programming mode always follow the same model.

Example: Proceed as follows to change the amount of water for 1 coffee from 100 ML to 120 ML and the temperature from NORMAL to HIGH.

-  ▶ Keep the Rotary Switch pressed until RINSE appears.
-  ▶ Turn the Rotary Switch until BUTTONS is displayed.
-  ▶ Press the Rotary Switch to enter the programme item.
SELECT BUTTON

-  Next select the product for which you would like to make settings.
-  To enter a setting for the double product, touch the corresponding symbol twice within a period of two seconds.

5 Permanent settings in programming mode

-  ▶ Touch the Coffee symbol.
1 COFFEE is displayed for about two seconds.
WATER
-  ▶ Press the Rotary Switch to enter the programme item.
100 ML (example)
-  ▶ Turn the Rotary Switch until **120 ML** is displayed.
-  ▶ Press the Rotary Switch to confirm the setting.
OK appears briefly on the display.
WATER
-  ▶ Turn the Rotary Switch until **TEMP.** is displayed.
-  ▶ Press the Rotary Switch to enter the programme item.
NORMAL
-  ▶ Turn the Rotary Switch until **HIGH** is displayed.
-  ▶ Press the Rotary Switch to confirm the setting.
OK appears briefly on the display.
TEMP.
-  ▶ Turn the Rotary Switch until **EXIT** is displayed.
-  ▶ Press the Rotary Switch to exit the programme item.
BUTTONS
-  ▶ Turn the Rotary Switch until **EXIT** is displayed.
-  ▶ Press the Rotary Switch to exit programming mode.
READY

Energy-saving mode

In the programme item **ENERGY** you can permanently set an energy-saving mode (Energy Save Mode, E.S.M.[®]):

- **SAVE -**
 - All coffee products as well as hot water can be prepared without having to wait.
 - Before steam preparation, the machine heats up.
- **SAVE ✓**
 - Approximately five minutes after the last preparation the IMPRESSA switches to the energy-saving temperature and is not in stand-by mode. When the machine is at energy-saving temperature, this is indicated on the display by the message **ENERGY ON.**
 - Before the preparation of coffee, hot water or steam, the machine heats up.

Example: Proceed as follows to change the energy-saving mode from **SAVE –** to **SAVE ✓**.

- ▶ Keep the Rotary Switch pressed **until RINSE** appears.
- ▶ Turn the Rotary Switch until **ENERGY –** is displayed.
- ▶ Press the Rotary Switch to enter the programme item.
SAVE –
- ▶ Turn the Rotary Switch until **SAVE ✓** is displayed.
- ▶ Press the Rotary Switch to confirm the setting.
OK appears briefly on the display.
ENERGY ✓
- ▶ Turn the Rotary Switch until **EXIT** is displayed.
- ▶ Press the Rotary Switch to exit programming mode.
READY

Automatic switch-off

By instructing your IMPRESSA to automatically switch itself off, you can cut down your energy consumption. If this function is activated, your IMPRESSA switches off automatically after the pre-set time following the last action on the machine.

- i** You can set the automatic switch-off to 15 minutes, or 0.5 hours up to 15 hours.







Example: Proceed as follows to change the automatic switch-off from **1 HRS** to **15 MIN**.

- ▶ Keep the Rotary Switch pressed **until RINSE** appears.
- ▶ Turn the Rotary Switch until **OFF AFTER** is displayed.
- ▶ Press the Rotary Switch to enter the programme item.
1 HRS
- ▶ Turn the Rotary Switch until **15 MIN** is displayed.
- ▶ Press the Rotary Switch to confirm the setting.
OK appears briefly on the display.
OFF AFTER
- ▶ Turn the Rotary Switch until **EXIT** is displayed.
- ▶ Press the Rotary Switch to exit programming mode.
READY

Rinsing

You can set whether the switch-on rinse should be started manually or automatically.

Example: Proceed as follows to specify that the switch-on rinse should be started **automatically** after switching on.



-  ▶ Keep the Rotary Switch pressed **until** **RINSE** appears.
-  ▶ Turn the Rotary Switch until **RINSING** is displayed.
-  ▶ Press the Rotary Switch to enter the programme item.
MANUAL
-  ▶ Turn the Rotary Switch until **AUTOMATIC** is displayed.
-  ▶ Press the Rotary Switch to confirm the setting.
OK appears briefly on the display.
RINSING
-  ▶ Turn the Rotary Switch until **EXIT** is displayed.
-  ▶ Press the Rotary Switch to exit programming mode.
READY

Restore factory settings

In the programme item **RESET** you can restore various settings to their factory settings:

- **PRODUCT**
 - The settings (amount of water, strength, temperature) for any product can be restored **individually** to the factory settings. The corresponding double product is reset at the same time.
- **ALL PROD.**
 - The settings (amount of water, strength, temperature) for **all products** are restored to the factory settings.
- **RESET ALL**
 - **All customer settings** are restored to the factory settings. The IMPRESSA then switches off.

Example: Proceed as follows to restored the values for 'Espresso' to the factory settings.

-  ▶ Keep the Rotary Switch pressed **until** **RINSE** appears.
-  ▶ Turn the Rotary Switch until **RESET** is displayed.
-  ▶ Press the Rotary Switch to enter the programme item.
PRODUCT







- ☞ ▶ Touch the Espresso symbol.
OK appears briefly on the display, the settings for 'Espresso' are restored to the factory settings.
PRODUCT
- ⦿ ▶ Turn the Rotary Switch until EXIT is displayed.
- ⦿ ▶ Press the Rotary Switch to exit the programme item.
RESET
- ⦿ ▶ Turn the Rotary Switch until EXIT is displayed.
- ⦿ ▶ Press the Rotary Switch to exit programming mode.
READY

Viewing information and maintenance status

In the programme item INFO you can query the following information:

- Number of prepared speciality coffees, hot water and steam
- Maintenance status and number of maintenance programmes performed (cleaning, descaling, changing the filter)
- Software version







- ⦿ ▶ Keep the Rotary Switch pressed until RINSE appears.
- ⦿ ▶ Turn the Rotary Switch until INFO is displayed.
- ⦿ ▶ Press the Rotary Switch to enter the programme item.
BUTTONS
- ⦿ ▶ Press the Rotary Switch to enter the programme item.
The **total number** of the prepared speciality coffees is displayed.
- i** By touching the individual symbols for the speciality coffees, hot water and steam, the respective number of prepared products is displayed.
- i** To query the number of double products prepared, touch the corresponding symbol for the speciality coffee twice.
- i** Open the cover of the filler funnel for pre-ground coffee to query this number.
- ⦿ ▶ Press the Rotary Switch to exit the programme item.
BUTTONS
- ⦿ ▶ Turn the Rotary Switch until CLEAN is displayed.

- i** Continue turning the Rotary Switch to switch to the performed descaling and filter change operations.
-  ▶ Press the Rotary Switch to enter the programme item.
The number of performed cleaning operations appears on the display.
- i** By turning the Rotary Switch, the maintenance status can also be displayed in addition to the number of performed maintenance programmes. The filled out fields show the maintenance status. Once all fields are filled out, your IMPRESSA will request the respective maintenance programme.
-  ▶ Press the Rotary Switch to exit the programme item.
CLEAN
-  ▶ Turn the Rotary Switch until **EXIT** is displayed.
-  ▶ Press the Rotary Switch to exit the programme item.
INFO
-  ▶ Turn the Rotary Switch until **EXIT** is displayed.
-  ▶ Press the Rotary Switch to exit programming mode.
READY

Unit for amount of water

You can change the unit for the amount of water from 'ml' to 'oz'.

Example: Proceed as follows to change the unit for the amount of water from **ML** to **OZ**.

-  ▶ Keep the Rotary Switch pressed **until RINSE** appears.
-  ▶ Turn the Rotary Switch until **DISPLAY** is displayed.
-  ▶ Press the Rotary Switch to enter the programme item.
ML
-  ▶ Turn the Rotary Switch until **OZ** is displayed.
-  ▶ Press the Rotary Switch to confirm the setting.
OK appears briefly on the display.
DISPLAY
-  ▶ Turn the Rotary Switch until **EXIT** is displayed.
-  ▶ Press the Rotary Switch to exit programming mode.
READY

Language

The language of your IMPRESSA is set with this programme item.

Example: Proceed as follows to change the language from **ENGLISH** to **DEUTSCH**.

Precondition: **READY** is displayed.

- ▶ Keep the Rotary Switch pressed **until RINSE** appears.
- ▶ Turn the Rotary Switch until **LANGUAGE** is displayed.
- ▶ Press the Rotary Switch to enter the programme item.
ENGLISH
- ▶ Turn the Rotary Switch until **DEUTSCH** is displayed.
- ▶ Press the Rotary Switch to confirm the setting.
OK appears briefly on the display.
SPRACHE
- ▶ Turn the Rotary Switch until **EXIT** is displayed.
- ▶ Press the Rotary Switch to exit programming mode.
BEREIT

6 Maintenance

Your IMPRESSA has the following integrated maintenance programmes:

- Rinsing the machine
- Changing the filter
- Cleaning the machine
- Descaling the machine

i Clean or descale the machine or change the filter when you are prompted to do so.

Maintenance tips

To ensure that you get many years of reliable service out of your IMPRESSA and to guarantee the optimum coffee quality, the machine requires daily maintenance.

Proceed as follows:

- Empty the coffee grounds container and the drip tray. Rinse them with warm water.
- Rinse the water tank with clean water.
- Dismantle and rinse the frother (see Chapter 6, 'Maintenance – Dismantling and rinsing the cappuccino frother').
- Wipe the surface of the machine with a clean, soft, damp cloth (e.g. microfibre cloth).

Rinsing the machine

When the IMPRESSA is switched on, a prompt to perform rinsing appears after heating, or this is automatically started. It can be set in programming mode whether the switch-on rinse needs to be activated manually or whether the machine automatically activates the switch-on rinse (see Chapter 5, 'Permanent settings in programming mode - Rinses').

When the IMPRESSA is switched off, a rinse operation is automatically initiated.

You can initiate the rinse operation manually at any time.



Precondition: **READY** is displayed.

- ▶ Place a receptacle under the coffee spout.
- ⌚ ▶ Keep the Rotary Switch pressed **until RINSE** appears.
- ⌚ ▶ Press the Rotary Switch to enter the programme item. **RINSE**
- ⌚ ▶ Press the Rotary Switch to initiate the rinse operation. **RINSING**, water flows out of the coffee spout. Rinsing stops automatically and your IMPRESSA is then ready for use.

Changing the filter

- i** After 50 litres of water have flowed through, the filter will cease to work. Your IMPRESSA will automatically prompt you to change the filter.
- i** After two months, the filter will cease to work. You can check the elapsed time by referring to the date plate on the cartridge holder in the water tank.
- i** If the CLARIS Blue filter cartridge is not activated, you will not be prompted to change the filter.

@ You can also try out the 'changing the filter' operation online. Visit the Knowledge Builder at www.jura.com.

Changing after a prompt

Proceed as follows to change the CLARIS Blue filter cartridge when prompted to do so by your IMPRESSA.

Precondition: **READY / FILTER** is displayed and the maintenance button  lights up.

-  ▶ Press the maintenance button. **CHANGE**
- ▶ Remove and empty the water tank.
- ▶ Lift the cartridge holder.
- ▶ Take out the old filter cartridge and the extension.
- ▶ Fit the extension on top of a new filter cartridge.

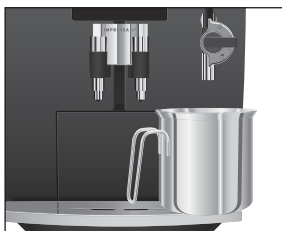

- ▶ Insert the filter cartridge into the water tank, exerting slight pressure.
- ▶ Close the cartridge holder. It will click into place audibly.
- ▶ Fill the water tank with fresh, cold water and reinsert the tank.

- ▶ Place a receptacle (at least 500 ml) under the frother.

i If you are using the **Professional Cappuccino Frother**, set the selector switch of the frother to the steam position \downarrow .

- ❖ ▶ Press the maintenance button.
FILTER RINSING, water will flow out of the frother.

i You can interrupt rinsing of the filter at any time. To this purpose press the maintenance button ❖.

i The water may be slightly discoloured. This is not harmful to health and does not affect the taste.

Rinsing of the filter stops automatically after approximately 500 ml. The IMPRESSA heats up and is once more ready for use.

Changing the filter manually

You can initiate the 'Changing the filter' operation manually.

Precondition: The filter is activated and **READY** is displayed.

 ▶ Keep the Rotary Switch pressed **until RINSE** appears.

 ▶ Press the Rotary Switch to enter the programme item.
RINSE

 ▶ Turn the Rotary Switch until **FILTER** is displayed.

 ▶ Press the Rotary Switch.
CHANGE

- ▶ Continue with the **second** prompt to take action (indicated by a ▶), as is described under '**Changing after a prompt**'.

Cleaning the machine

After 200 coffee preparations or 80 switch-on rinses, the IMPRESSA will prompt you to clean it.

CAUTION

If the wrong cleaning agent is used, the machine could be damaged and/or traces of detergent could be left behind in the water.

- ▶ Use only original JURA maintenance products.

- i** The cleaning programme only lasts about 20 minutes.
- i** Do not interrupt the cleaning programme. The quality of cleaning will be impaired if you do so.
- i** JURA cleaning tablets are available from stockists.

@ You can also try out the 'Cleaning the machine' operation online. Visit the Knowledge Builder at www.jura.com.

Cleaning after a prompt

Precondition: **READY / CLEAN** is displayed and the maintenance button  lights up.

-  ▶ Press the maintenance button.

EMPTY TRAY

- ▶ Empty the drip tray and coffee grounds container and put them back into the machine.

PRESS RINSE, the maintenance button  lights up.

- ▶ Place a receptacle under the coffee spout.

-  ▶ Press the maintenance button.

CLEANING, water flows out of the coffee spout.

The operation is interrupted, **ADD TABLET**.

- ▶ Open the cover of the filler funnel for pre-ground coffee.

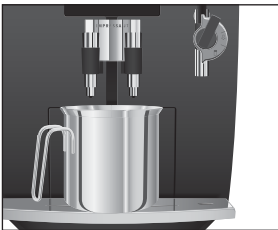

- ▶ Insert a JURA cleaning tablet into the filler funnel.

- ▶ Close the cover of the filler funnel.

PRESS RINSE, the maintenance button  lights up.

-  ▶ Press the maintenance button.

CLEANING, water flows out of the coffee spout several times.

The operation is interrupted, **EMPTY TRAY**.





- ▶ Empty the drip tray and coffee grounds container and put them back into the machine.

The cleaning operation is now complete. The IMPRESSA is once more ready for use.

Manual cleaning

You can initiate the 'Cleaning the machine' operation manually.

Precondition: **READY** is displayed.

-  ▶ Keep the Rotary Switch pressed **until RINSE** appears.
-  ▶ Press the Rotary Switch to enter the programme item.
RINSE
-  ▶ Turn the Rotary Switch until **CLEAN** is displayed.
-  ▶ Press the Rotary Switch.
EMPTY TRAY
- ▶ Continue with the **second** prompt to take action (indicated by a ▶), as is described under '**Cleaning after a prompt**'.

Descaling the machine

The IMPRESSA builds up deposits of limescale over time and automatically prompts you to descale it when necessary. The degree of calcification depends on the degree of hardness of your water.



If the descaling agent comes into contact with the skin or eyes, this can cause irritation.

- ▶ Avoid contact with the skin or eyes.
- ▶ If descaling agent does come into contact with the skin or eyes, rinse off with clean water. Should you get any descaling agent in your eye, see a doctor.



If the wrong descaling agent is used, the machine could be damaged and/or traces of detergent could be left behind in the water.

- ▶ Use only original JURA maintenance products.



If the descaling operation is interrupted, there may be damage to the machine.

- ▶ Allow the descaling programme to run to the end.



If the descaling agent comes into contact with sensitive surfaces, damage cannot be ruled out.

- ▶ Clean up any splashes immediately.

- i** The descaling programme lasts approx. 45 minutes.
 - i** JURA descaling tablets are available from stockists.
 - i** If you use a CLARIS Blue filter cartridge and this is activated, you will not be prompted to descale.
- @ You can also try out the 'Descaling the machine' operation online. Visit the Knowledge Builder at www.jura.com.

Descaling after a prompt

Precondition: **READY / DE-SCALE** is displayed and the maintenance button  lights up.

-  ▶ Press the maintenance button.

EMPTY TRAY

- ▶ Empty the drip tray and coffee grounds container and put them back into the machine.

AGENT IN TANK

- ▶ Remove and empty the water tank.
- ▶ Completely dissolve the contents of one blister (three JURA descaling tablets) in a container that holds 500 ml of water. This may take several minutes.
- ▶ Pour the solution into the empty water tank and insert it in the machine.

AGENT IN TANK, the maintenance button  lights up.

- ▶ Remove the cappuccino frother from the Connector System[®].
- ▶ Place a receptacle (at least 500 ml) under the Connector System[®].

-  ▶ Press the maintenance button.

DE-SCALING

This causes water to flow out of the Connector System[®] several times. The maintenance button blinks during the descaling operation.

The operation stops automatically, **EMPTY TRAY**.

- ▶ Empty the receptacle under the Connector System[®].
- ▶ Empty the drip tray and coffee grounds container and put them back into the machine.

FILL WATER TANK

- ▶ Remove the water tank and rinse it thoroughly.

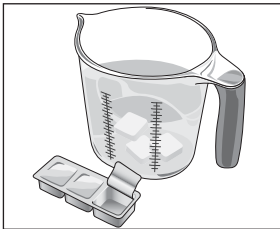



- ▶ Fill the water tank with fresh, cold water and reinsert the tank.
PRESS RINSE, the maintenance button ☼ lights up.
- ▶ Replace the cappuccino frother.
- ▶ Place a receptacle under the frother and another under the coffee spout.
- ☼ ▶ Press the maintenance button.
DE-SCALING, water flows out of the frother and the coffee spout.
The operation stops automatically, **EMPTY TRAY**.
- ▶ Empty the drip tray and coffee grounds container and put them back into the machine.
The descaling operation is now complete. Your IMPRESSA heats up and is once more ready for use.

i If the descaling operation stops unexpectedly, rinse the water tank thoroughly.

Manual descaling

You can initiate the 'Descaling the machine' operation manually.

Precondition: **READY** is displayed and the filter is not activated.

- ⌚ ▶ Keep the Rotary Switch pressed **until RINSE** appears.
- ⌚ ▶ Press the Rotary Switch to enter the programme item.
RINSE
- ⌚ ▶ Turn the Rotary Switch until **DE-SCALE** is displayed.
- ⌚ ▶ Press the Rotary Switch.
EMPTY TRAY
- ▶ Continue with the **second** prompt to take action (indicated by a ▶), as is described under '**Descaling after a prompt**'.

Rinsing the cappuccino frother



i This chapter applies to the **Professional** and **Easy Cappuccino Frothers**.

To ensure that the cappuccino frother works perfectly, you should rinse it with water **after every** milk preparation. Your IMPRESSA will **not** prompt you to rinse the cappuccino frother.

Precondition: **READY** is displayed.

- ▶ Remove the milk pipe from the milk carton/bottle or the milk container.
- ▶ Fill a receptacle with fresh water and immerse the milk pipe in it.
- ▶ Place a receptacle under the cappuccino frother.



i If you are using the **Professional Cappuccino Frother**, turn the selector switch to the milk foam  or milk  position.

 ▶ Touch the Steam symbol.

HEATING

As soon as the machine has heated up, **READY** appears.

 ▶ Touch the Steam symbol again.

STEAM, the frother and milk pipe are rinsed.

START ▶ Touch the Start symbol as soon as clean water flows out of the frother.

The operation stops and your IMPRESSA is once more ready for use.

Cleaning the cappuccino frother

i This chapter applies to the **Professional** and **Easy Cappuccino Frothers**.

To ensure that the cappuccino frother works perfectly, you should clean it **daily** when you have been preparing milk. Your IMPRESSA will **not** prompt you to clean the cappuccino frother.

CAUTION

If the wrong cleaning agent is used, the machine could be damaged and/or traces of detergent could be left behind in the water.

- ▶ Use only original JURA maintenance products.



i JURA Cappuccino Cleaner is available from stockists.

@ You can also try out the 'Cleaning the cappuccino frother' operation online. Visit the Knowledge Builder at www.jura.com.

Precondition: **READY** is displayed.

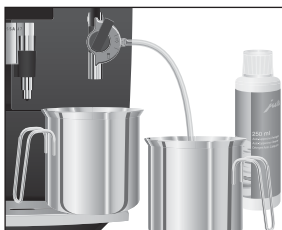
- ▶ Remove the milk pipe from the milk carton/bottle or the milk container.
- ▶ Pour 250 ml of fresh water into a receptacle and add one capful (max. 15 ml) of Cappuccino Cleaner.
- ▶ Immerse the milk pipe in the receptacle.
- ▶ Place another receptacle under the frother.



i If you are using the **Professional Cappuccino Frother**, turn the selector switch to the milk foam  or milk  position.

⬇ ▶ Touch the Steam symbol.

HEATING

As soon as the machine has heated up, **READY** appears.

⬇ ▶ Touch the Steam symbol again.

STEAM, the frother and milk pipe are cleaned.

START ▶ Touch the Start symbol as soon as the receptacle containing the Cappuccino Cleaner is empty.

▶ Rinse the receptacle thoroughly, fill it with approx. 250 ml of fresh water and immerse the milk pipe in the water.

▶ Empty the other receptacle and place it under the frother once more.

⬇ ▶ Touch the Steam symbol.

STEAM, the frother and milk pipe are rinsed with fresh water.

START ▶ Touch the Start symbol as soon as the receptacle containing the water is empty.

The operation stops and your IMPRESSA is once more ready for use.



Dismantling and rinsing the Professional Cappuccino Frother

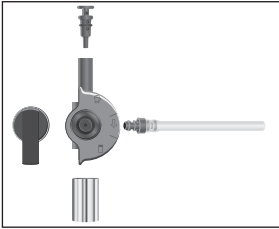

- ▶ Carefully remove the frother from the Connector System[®] by twisting slightly.
- ▶ Dismantle the frother completely.
- ▶ Rinse all frother parts thoroughly under running water.
- ▶ Re-assemble the frother.

i Ensure that all individual parts are correctly and firmly connected to ensure correct operation of the frother

- ▶ Firmly attach the frother to the Connector System[®].

Dismantling and rinsing the Easy Cappuccino Frother

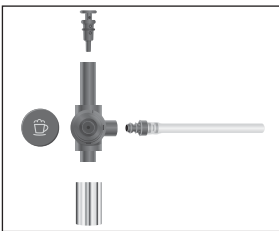

- ▶ Carefully remove the frother from the Connector System[®] by twisting slightly.
- ▶ Dismantle the frother completely.
- ▶ Rinse all frother parts thoroughly under running water.
- ▶ Re-assemble the frother.

i Ensure that all individual parts are correctly and firmly connected to ensure correct operation of the frother.



- ▶ Firmly attach the frother to the Connector System[®].

Cleaning the bean container

Coffee beans may be covered with a slight oil film which remains on the walls of the bean container. These residues may negatively affect the coffee results. For this reason clean the bean container from time to time.



Danger of injury to the fingers when the grinder is running.

- ▶ Switch the machine off with the on/off button  before performing any work on the grinder.
 - ▶ Switch the machine off at the power switch .
-

- ▶ Open the bean container cover and remove the aroma preservation cover.

6 Maintenance

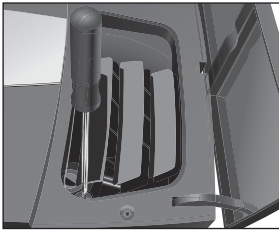

- ▶ Loosen the screw in the bean container and lift up the finger protection.
- ▶ Remove the remaining beans with a vacuum cleaner.
- ▶ Clean the bean container with a soft, dry cloth.
- ▶ Put the finger protection down again and screw it back tightly in place.
- ▶ Fill the bean container with coffee beans.
- ▶ Close the aroma preservation cover and the bean container cover.

Descaling the water tank

Limescale deposits may form in the water tank. To ensure correct function of the machine, descale the water tank from time to time.

- ▶ Remove the water tank.
- ▶ If you use a CLARIS Blue filter cartridge, remove this.
- ▶ Descale the tank with a mild conventional descaling agent in accordance with the manufacturer's instructions.
- ▶ Rinse out the water tank thoroughly.
- ▶ If you use a CLARIS Blue filter cartridge, insert this again.
- ▶ Fill the water tank with fresh, cold water and reinsert the tank.

7 Display messages

Message	Cause/Result	Action
FILL WATER TANK	The water tank is empty. You cannot prepare any speciality coffee or hot water or steam.	▶ Fill the water tank (See Chapter 2, 'Preparing and using for the first time – Filling the water tank').
EMPTY GROUNDS	The coffee grounds container is full. You cannot prepare any speciality coffees, but you can prepare hot water or steam.	▶ Empty the coffee grounds container and the drip tray.
EMPTY TRAY	The drip tray is full. You cannot prepare any speciality coffees or hot water or steam.	▶ Empty the drip tray.
TRAY MISSING	The drip tray is not inserted correctly or is not inserted at all. You cannot prepare any speciality coffees or hot water or steam.	▶ Insert the drip tray.
FILL BEANS	The bean container is empty. You cannot prepare any speciality coffees with beans. You can prepare pre-ground coffee, hot water and steam.	▶ Fill the bean container (See Chapter 2, 'Preparing and using for the first time – Filling the bean container').
READY / CLEAN	After 200 preparations or 80 switch-on rinses, the IMPRESSA will prompt you to clean it.	▶ Clean the machine (See Chapter 6, 'Maintenance – Cleaning the machine').
READY / DE-SCALE	The IMPRESSA is prompting you to descale it.	▶ Descale the machine (See Chapter 6, 'Maintenance – Descaling the machine').
READY / FILTER	After 50 litres of water have flowed through the filter cartridge, it will cease to work.	▶ Replace the CLARIS Blue filter cartridge (see Chapter 6 'Maintenance – Changing the filter').

7 Display messages

Message	Cause/Result	Action
NOT ENOUGH PRE-GROUND	There is too little pre-ground coffee in the machine; the IMPRESSA stops the operation.	► The next time you prepare coffee use more pre-ground coffee (see Chapter 4 'Preparation at the touch of a button – Pre-ground coffee').
TOO HOT	The system is too hot to start a maintenance programme.	► Prepare a speciality coffee or hot water.

8 Troubleshooting

Problem	Cause/Result	Action
Insufficient foam is produced when the milk is frothed or milk sprays from the cappuccino frother.	The cappuccino frother is dirty.	▶ Rinse and clean the cappuccino frother (see Chapter 6, 'Maintenance – Cappuccino frother').
Coffee only comes out in drips when it is being prepared.	Coffee or pre-ground coffee has been ground too finely and is blocking the system.	▶ Put the grinder on a coarser setting or use coarser pre-ground coffee (refer to Chapter 2, 'Preparing and using for the first time – Adjusting the grinder').
Water hardness cannot be adjusted.	The CLARIS Blue filter cartridge is activated.	▶ Deactivate the filter cartridge in programming mode.
FILL BEANS is displayed although the bean container has been filled.	The grinder is not yet completely filled with beans.	▶ Prepare a speciality coffee.
FILL BEANS is not displayed although the bean container is empty.	The bean monitor is dirty.	▶ Clean the bean container (see Chapter 6, 'Maintenance – Cleaning the bean container').
EMPTY TRAY is always displayed.	The metal contacts of the drip tray are dirty or wet.	▶ Clean and dry the metal contacts on the back of the drip tray.
FILL WATER TANK is displayed although the water tank is full.	The water tank float is trapped.	▶ Descale the water tank (see Chapter 6, 'Maintenance – Descaling the water tank').
Grinder is making a very loud noise.	There are foreign objects in the grinder.	▶ Contact Customer Support in your country (see Chapter 'JURA contact details / Legal information').

Problem	Cause/Result	Action
Little or no water or steam comes out of the frother. The pump is very quiet.	The Connector System® may be blocked by milk residues or descaling fragments loosened during descaling.	<ul style="list-style-type: none"> ▶ Remove the frother from the Connector System®. ▶ Unscrew the black connector with the aid of the hexagonal hole on the measuring spoon for pre-ground coffee. ▶ Clean the connector thoroughly. ▶ Manually screw the connector back on to the Connector System®. ▶ Carefully tighten it using the hexagonal hole on the measuring spoon, turning by no more than a quarter of a rotation.
ERROR 2 is displayed.	If the machine was exposed to the cold for a long period of time, heating is disabled for safety reasons.	<ul style="list-style-type: none"> ▶ Warm the machine at room temperature.
Other ERROR messages are displayed.	–	<ul style="list-style-type: none"> ▶ Turn the IMPRESSA off at the power switch. Contact Customer Support in your country (see Chapter 'JURA contact details / Legal information').

i If you were unable to solve the problem, contact Customer Support in your country (see Chapter 'JURA contact details / Legal information').

9 Transport and environmentally neutral disposal

Transport / Emptying the system

Keep the packaging for your IMPRESSA. It should be used to protect the machine during transport.

In order to protect the IMPRESSA from frost during transport, the system must be emptied.

Precondition: **READY** is displayed.

- ▶ Carefully pull the cappuccino frother off the Connector System®.

- ▶ Place a receptacle under the Connector System®.

- ☚ ▶ Touch the Steam symbol.

HEATING

As soon as the machine has heated up, **READY** appears.

- ☚ ▶ Touch the Steam symbol again.

STEAM, hot steam is discharged from the Connector System®.

- ▶ Remove and empty the water tank.

Steam will continue to be discharged from the Connector System® until the system is empty.

PRESS RINSE

- ⏻ ▶ Press the on/off button.

The IMPRESSA is switched off.

- i** The next time you use the machine the system must be refilled (see Chapter 2, 'Preparing and using for the first time – First-time use').













Disposal

Please dispose of old machines in an environmentally neutral way.



Old machines contain valuable materials capable of being recycled which should be salvaged for recycling. Please therefore dispose of old machines via suitable collection systems.

10 Technical data

Voltage	 	220 –240 V ~, 50 Hz
		120 V ~, 60 Hz
		220 –240 V ~, 50 Hz
		220 V ~, 50 Hz
Power	1450 W	
Safety test	   	
Power consumption	12 Wh	
	ENERGY SAVE 	
Power consumption	7 Wh	
	ENERGY SAVE 	
Pump pressure	Static max. 15 bar	
Holding capacity of water tank	2,1 l	
Holding capacity of bean container	250 g	
Holding capacity of coffee grounds container	Approx. 16 servings	
Cable length	Approx. 1,1 m	
Weight	10,75 kg	
Dimensions (W x H x D)	28,5 x 34,2 x 43,3 cm	

Index

A

- Amount
 - Changing the amount of water during preparation 25
 - Entering a permanent setting for the amount of water for the cup size 26
- Amount of coffee
 - Changing the amount of water during preparation 25
 - Entering a permanent setting for the amount of water for the cup size 26
- Amount of water
 - Changing during preparation 25
 - Setting the water for the cup size 26
- Automatic switch-off 37

B

- Bean container 8
 - Cleaning 51
 - Filling 17
- Bus bar
 - Technical data 58

C

- Cappuccino 30
- Cappuccino frother
 - Cleaning 49
 - Easy Cappuccino Frother 9
 - Professional Cappuccino Frother 9
 - Rinsing 48
- CLARIS Blue (filter cartridge)
 - Changing 43
 - Inserting and activating 18, 19
- Cleaning
 - Bean container 51
 - Machine 45
- Coffee 29
- Coffee
 - Pre-ground coffee 31
- Coffee grounds container 8
- Coffee strength
 - Changing before preparation 25
- Connector System® 15
- Control options 23

D

- Descaling
 - Machine 46
 - Water tank 52
- Display
 - Messages 53
- Display messages 53
- Disposal 57
- Drip tray 8

E

- Easy Cappuccino Frother
 - Dismantling and rinsing 51
- Emptying the system 57
- Energy Save Mode 36
- Energy-saving mode 14
- Environmentally neutral disposal 57
- Errors
 - Troubleshooting 55
- Espresso 29

F

- Factory settings
 - Restore factory settings 38
- Filling
 - Bean container 17
 - Water tank 16
- Filter
 - Changing 43
 - Inserting and activating 18, 19
- First-time use 17
- Frother
 - Cleaning the cappuccino frother 49
 - Easy Cappuccino Frother 9, 15
 - Professional Cappuccino Frother 9, 15
 - Rinsing the cappuccino frother 48

G

- Grinder adjustment switch
 - Adjusting the grinder 20

H

- Hot milk
 - Foaming and heating with the Professional Cappuccino Frother 32
- Hot water 34
- Hot water nozzle 9

I

- Inserting
Water tank 16
- Internet 15

K

- Knowledge Builder 15

L

- Language 41

M

- Machine
 - Cleaning 45
 - Descaling 46
 - Rinsing 42
 - Setting up 16
 - Switching off (Standby) 22
 - Switching on 21
- Maintenance
 - Maintenance button 9
 - Maintenance tips 42
- Milk
 - Foaming and heating with the Professional Cappuccino Frother 32
 - Foaming with the Easy Cappuccino Frother 33
- Milk foam
 - With the Easy Cappuccino Frother 33
 - With the Professional Cappuccino Frother 32

N

- Nozzle
 - Hot water nozzle 9

O

- One-off settings before and during preparation 24

P

- Permanent settings in programming mode 35
- Pre-ground coffee 31
 - Pre-ground coffee 31
- Preparation
 - At the touch of a button 29
 - Cappuccino 30
 - Coffee 29
 - Espresso 29

- Hot water 34
- Pre-ground coffee 31
- Ristretto 29

Problems

- Troubleshooting 55
- Professional Cappuccino Frother 15
 - Dismantling and rinsing 51
- Programming mode 35
 - Automatic switch-off 37
 - Language 41
 - Permanent settings in programming mode 26
 - Products 35
 - Reset settings to factory settings 38

R

- Rinsing
 - Machine 42
- Ristretto 29

S

- Safety information 10
- Settings
 - Entering a permanent setting for the amount of water for the cup size 26
 - One-off settings before and during preparation 24
 - Permanent settings in programming mode 35
 - Setting up 16
 - Supplied as standard 16
 - Switching off 22
 - Switching on 21

T

- Technical data 58
- Transport 57
- Troubleshooting 55

V

- Viewing information and maintenance status 39
- Viewing maintenance status 39

W

- Water tank 8
 - Descaling 52
 - Filling 16

JURA contact details / Legal information

JURA Elektroapparate AG
Kaffeeweltstrasse 10
CH-4626 Niederbuchsiten
Tel.: +41 62 38 98 233

@ Further contact information is available on the company website at www.jura.com.

Directives

The machine complies with the following EU directives:

- 2006/95/EG – Low Voltage Directive
- 2004/108/EG – Electromagnetic Compatibility
- 2009/125/EG – Energy Directive

Technical changes

We reserve the right to make technical changes.

The illustrations used in the IMPRESSA J7 Manual show the IMPRESSA J7 Piano Black. Your IMPRESSA could incorporate minor changes.

Feedback

Your opinion is important to us!
Use the contact link at www.jura.com.

Copyright

The Instructions for Use contain information which is protected by copyright. It is not permitted to photocopy or translate these Instructions for Use into another language without the express written consent of JURA Elektroapparate AG.